

EXTC-SA[™]
REAMP[®]
EFFECTS REAMPER



User Guide

Radial® EXTC-SA™ Effects Reamper®

Table of Contents	Page
Feature Set	1
Overview	2
Getting Started	3
Specifications	4
Block Diagram	5
Warranty	Back cover

Congratulations and thank you for purchasing the Radial EXTC-SA Effects Reamper®. The EXTC-SA is a unique interface designed to allow you to introduce high impedance guitar pedals and effects into the recording world with relative ease while keeping the signal quiet. With the EXTC, you are set to add wah to a keyboard track, tube distortion to a vocal track or an envelope filter to the snare drum track. The EXTC is all about creativity and making sure your recording stands out from the rest.

This manual describes connecting and operating your EXTC-SA. To take full advantage of the unique features that have been incorporated into the EXTC-SA, please read through this guide before using it. This user guide will give you a broader sense of the units capabilities. If you have questions that are not covered in this manual, please visit the FAQ section on our website. This is where we post answers to questions from users. If you cannot find the answer to your question please feel free to send an email to info@radialeng.com and we will do our very best to respond as quickly as possible.

The Radial EXTC-SA Effects Reamper opens creative options to your recording world.

www.radialeng.com

FEATURE SET



1. POWER LED - Indicates when the unit is powered on.
2. SEND LEVEL - Used to adjust the output level going to the pedals and optimize signal-to-noise for best performance.
3. RECEIVE LEVEL - Used to set the effects loop return level and further optimize signal-to-noise.
4. 180° POLARITY INVERT - Lets you adjust the polarity of the wet signal path and bring it into phase with the dry signal when they are being mixed together.
5. BLEND - Lets you adjust the wet-dry mix between the original unprocessed signal and the EXTC-SA effects loops.
6. LOOPS ON/OFF - Turns the A & B loops on and off. An LED indicator illuminates when a loop is active.
7. BOOKEND DESIGN - Enclosure design creates a protective zone around the front controls.
8. POWER ADAPTER - Connection for the included power supply with handy cable clamp to prevent accidental disconnection.
9. 1/4" SEND and RECV - Separate LOOP-A & B send and receive jacks used to connect guitar pedals to the EXTC-SA. LOOP-A is transformer isolated to eliminate hum and buzz caused by ground loops.
10. XLR I/O - Balanced line-level input and output jacks for connection to professional audio devices.
11. 1/4" TRS I/O - Balanced/unbalanced line-level input and output phone jacks.
12. FULL BOTTOM PAD - Won't scratch, keeps the EXTC-SA in one place and provides electrical isolation.

OVERVIEW

The Radial EXTC-SA is a professional audio interface that takes a +4dB balanced line-level signal and converts it to a guitar-level effects loop and then re-converts it back to a +4dB balanced line-level signal. In other words, you send in a balanced signal from your recorder, adjust the loop send level that drives the pedals. Set the return level from the pedals as it comes back and send the resulting signal to your recording system.

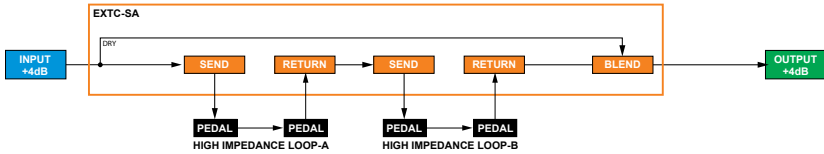

Although simple in principle, the key to the EXTC-SA's performance is how quietly it does the task. This is achieved by employing full sized discrete electronic components, class-A circuitry and transformer isolation to help eliminate the hum and buzz that is common with pedals and guitars. The other cool 'trick' inside the EXTC-SA is the blend control. This mixes the original dry signal with the newly introduced effects created by the pedals.

Something to think about here is how some effect pedals will reverse the polarity of the signal passing through them. When you mix a dry signal with a wet signal and one is polarity reversed, you will of course end up with cancellation. The diagram below illustrates a setup where one pedal "B" is inverting the polarity creating cancellation where two out-of-phase signals come together.

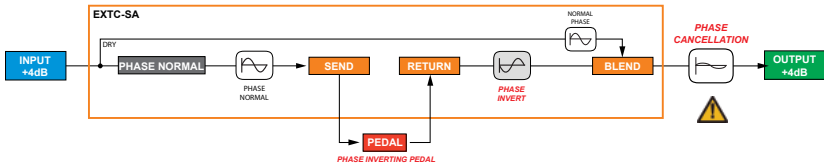

The PHASE INVERT switch plays an important role by ensuring both the dry and wet signals are in phase. The next diagram shows how the PHASE INVERT switch reverses the signal polarity before it gets to the offending pedal. Pedal "B" gets tricked into re-inverting the signal back to normal phase.

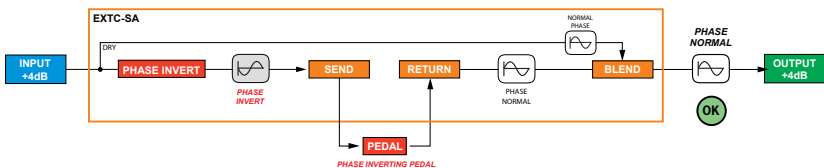

GETTING STARTED

Before making any connections, start by turning off your audio system and turning all volume levels down. This helps protect equipment from turn-on transients that could damage loudspeakers and other sensitive equipment. Connect the external power supply to the EXTC-SA. There is no power switch. The EXTC-SA will power up as soon as you connect the supply. An LED on the front panel will illuminate when power is connected.

Start by setting up the controls as follows:

1. Set the blend control to the wet position (fully-clockwise).
2. Make sure the PHASE INVERT is set to normal (switch outward).
3. Set the send and receive level controls at mid-way (12 o'clock).

Connections between the EXTC-SA and your pedals are made via the unbalanced high impedance ¼" LOOP-A & B jacks. Connections to the recording system are made through the balanced XLR and ¼" TRS inputs and outputs jacks.

Connect the +4dB output from your recorder to the balanced INPUT on the rear panel. To send the processed signal back, connect the balanced EXTC-SA output back to your recording system and route the signal to a new track. To connect your pedals, simply patch from the high-Z ¼" SEND jack to your pedal chain input. The output of the pedal chain is returned to the EXTC-SA by connecting to the RECV jack. We suggest you start with one pedal patched into LOOP-A before connecting more pedals to LOOP-B. This will make it easier to trouble shoot when first setting up the EXTC-SA.

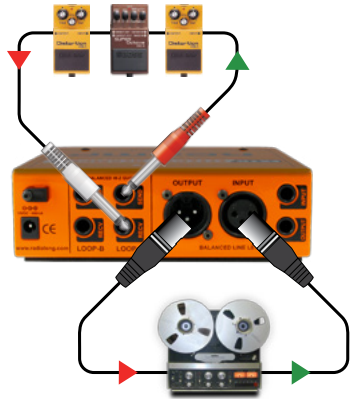

Turn on the effect pedal and select LOOP-A by depressing the the front panel switch. An LED will indicate LOOP-A is active. Press play on your recorder and send the track to the EXTC-SA input. You should be able to monitor the return path in your recording system and hear the effect. Separate SEND & RECEIVE controls make it easy to adjust the levels to suit any effect device. Now, try varying the BLEND control by rotating it counter-clockwise towards the dry setting to hear how the effect mixes with the original track. If you notice that the signal is 'thinning out' when the BLEND control is around the 12 o'clock position the wet and dry signals may be out-of-phase with each other. The 'thinning out' is the result of phase cancellation between the wet and dry signals. Try depressing the PHASE INVERT switch to fix the problem. If all is well, try adding more pedals and connecting LOOP-B.

Once you get the EXTC hooked up, you will find it to be loads of fun! All of a sudden, you will be going back into the attic looking for that box of forgotten pedals, dusting them off and plugging them in. Some will sound fantastic, others will sound bad in a good way. Who knows, only those brave enough to enter blindly into these cold waters may live to tell the tale. One of the most common applications for the EXTC-SA is using it to add grit to a vocal track. This can easily be done with a distortion or overdrive pedal. You will find that the most realistic effects are created by blending slight amounts of distortion with the dry signal. But you can also have loads of fun creating Nine Inch Nails type tones and generally going crazy. There are no rules, only guidelines.

RADIAL EXTC-SA SPECIFICATIONS

Circuit type: Class-A discrete, transformer coupled
 Power requirement: Radial 15VDC/400mA power supply included

	DRY	WET
Frequency Response:	20Hz ~ 20kHz +/- 1.5dB	20Hz ~ 10kHz +/- 3.5dB (-8dB @ 20kHz) Shaped for musical instruments
Voltage Gain:	0dB	12dB - send & receive at max 6dB - send minimum, receive max 0dB - send & receive set at 12 o'clock
THD+N (1kHz):	<0.005% @ 0dBu	<0.002% @ 0dBu
Noise:	-93dB	-84dB
Intermodulation Distortion:	<0.003% @ 0dBu input	<0.02% @ 0dBu input
Maximum input:	+11dBu	+11dBu

Line Level I/O	XLR & ¼" TRS INPUT	XLR & ¼" TRS OUTPUT
Type:	Rear Panel Input - Balanced XLR Female & ¼" TRS	Rear Panel Output - Balanced XLR Male & ¼" TRS
Impedance:	15k Ohms	200 Ohms
Headroom:	-	+25dBu

Effects Loop I/O	SEND 1/4" output	RECEIVE 1/4" input
Type:	Unbalanced ¼"	Unbalanced ¼"
Impedance:	1.5k Ohms	10K ohms
Gain (variable):	From -14dB ~ +3dB (0dB at center point)	From -99dB ~ +9dB (0dB at center point)
Maximum Gain:	+3dB	+9dB

All voltage gain specs with both effect loops bypassed. Insertion of effects units will vary gain somewhat due to their particular input and output impedances.

CONNECTOR WIRING

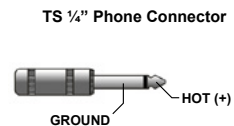
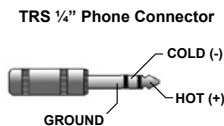
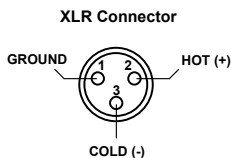

RADIAL EXTC-SA BLOCK DIAGRAM

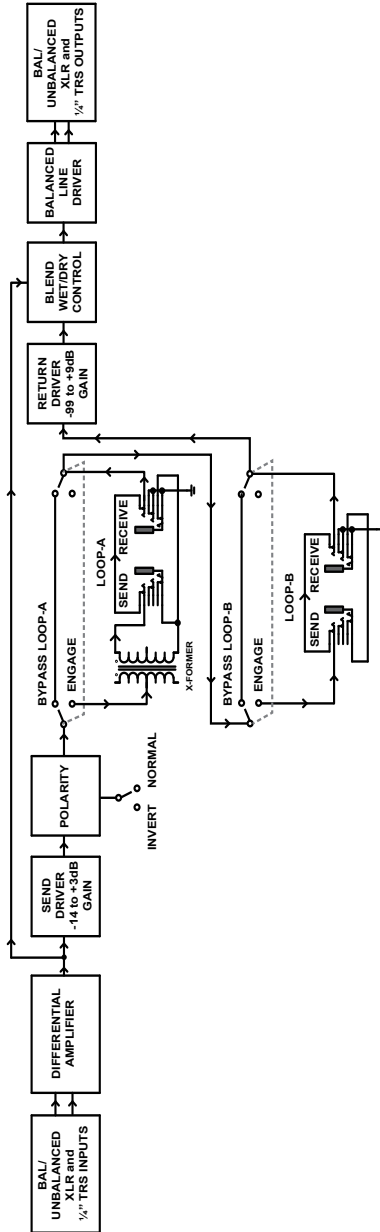

THREE YEAR TRANSFERABLE LIMITED WARRANTY

RADIAL ENGINEERING LTD. ("Radial") warrants this product to be free from defects in material and workmanship and will remedy any such defects free of charge according to the terms of this warranty. Radial will repair or replace (at its option) any defective component(s) of this product (excluding finish and wear and tear on components under normal use) for a period of three (3) years from the original date of purchase. In the event that a particular product is no longer available, Radial reserves the right to replace the product with a similar product of equal or greater value. In the unlikely event that a defect is uncovered, please call 604-942-1001 or email service@radialeng.com to obtain an RA number (Return Authorization number) before the 3 year warranty period expires. The product must be returned prepaid in the original shipping container (or equivalent) to Radial or to an authorized Radial repair center and you must assume the risk of loss or damage. A copy of the original invoice showing date of purchase and the dealer name must accompany any request for work to be performed under this limited and transferable warranty. This warranty shall not apply if the product has been damaged due to abuse, misuse, misapplication, accident or as a result of service or modification by any other than an authorized Radial repair center.

THERE ARE NO EXPRESSED WARRANTIES OTHER THAN THOSE ON THE FACE HEREOF AND DESCRIBED ABOVE. NO WARRANTIES WHETHER EXPRESSED OR IMPLIED, INCLUDING BUT NOT LIMITED TO, ANY IMPLIED WARRANTIES OF MERCHANTABILITY OR FITNESS FOR A PARTICULAR PURPOSE SHALL EXTEND BEYOND THE RESPECTIVE WARRANTY PERIOD DESCRIBED ABOVE OF THREE YEARS. RADIAL SHALL NOT BE RESPONSIBLE OR LIABLE FOR ANY SPECIAL, INCIDENTAL OR CONSEQUENTIAL DAMAGES OR LOSS ARISING FROM THE USE OF THIS PRODUCT. THIS WARRANTY GIVES YOU SPECIFIC LEGAL RIGHTS, AND YOU MAY ALSO HAVE OTHER RIGHTS, WHICH MAY VARY DEPENDING ON WHERE YOU LIVE AND WHERE THE PRODUCT WAS PURCHASED.



True to the Music

Radial Engineering Ltd.

1845 Kingsway Ave., Port Coquitlam, BC V3C 1S9, Canada

tel: 604-942-1001 • fax: 604-942-1010 • email: info@radialeng.com

www.radialeng.com

REAMP®

ProTools and Neve are registered trademarks of their respective owners.

Reamp, Reamper, Reamping are trademarks of Radial Engineering Ltd.

Copyright 2012 Radial Engineering Ltd. All rights reserved.

Specifications and appearances subject to change without notice.

Radial® EXTC-SA™ User Guide Rev1.1 August 2021 - Part #: R870 1222 00

Printed in Canada 